

Breadman™

INSTRUCTION
MANUAL



CORNER BAKERY
BREAD & DESSERT MAKER
MODEL NUMBER TR888



TABLE OF CONTENTS

Important Safeguards	2
Additional Important Safeguards	3
Electric Power	3
Polarized Plug	3
Power Outage	4
Before Your First Use	4
Your Corner Bakery Bread & Dessert Maker	5
Control Panel	6
Using the Breadman®	7-9
Kneading and Baking Cycles	10
Program Specification Chart.....	11
Making Dough and Baking Bread	12-14
Using the Delay Bake Timer	15
Butter	16
Dessert	18
Cleaning Instructions	20
Storing	21
Troubleshooting	21-22
Bread and Dough Check List	23
Suggestions	24
In-Warranty Service Information	25
Specifications	26
Warranty.....	27



READ AND SAVE THESE INSTRUCTIONS

WARNING: A risk of fire and electrical shock exists in all electrical appliances and may cause personal injury or death. Please follow all safety instructions.

IMPORTANT SAFEGUARDS

When using electrical appliances, basic safety precautions should always be followed including the following:

1. **READ ALL INSTRUCTIONS.**
2. Do not touch hot surfaces. Use handles or knobs.
3. To protect against electrical shock do not immerse cord, plugs, or appliance in water or other liquid.
4. Close supervision is necessary when any appliance is used by or near children.
5. Unplug from outlet when not in use and before cleaning. Allow to cool before putting on or taking off parts.
6. Do not operate any appliance with a damaged cord or plug, or after the appliance malfunctions or has been damaged in any manner. Contact Consumer Service for examination, repair or adjustment.
7. The use of accessory attachments not recommended by the appliance manufacturer may cause injuries.
8. Do not use outdoors.
9. Do not let cord hang over edge of table or counter, or touch hot surfaces.
10. Do not place on or near a hot gas or electric burner, or in a heated oven.
11. Extreme caution must be used when moving an appliance containing hot oil or other hot liquids.
12. To disconnect, remove plug from wall outlet.
13. Do not use appliance for other than intended use.
14. Avoid contacting moving parts.

SAVE THESE INSTRUCTIONS FOR HOUSEHOLD USE ONLY

CAUTION: A short power-supply cord (or detachable power-supply cord) is provided to reduce the risk resulting from becoming entangled in or tripping over a longer cord.

Longer detachable power-supply cords or extension cords are available and may be used if care is exercised in their use.

If longer detachable power-supply cord or extension cord is used, (1) the marked electrical rating of the cord set or extension cord should be at least as great as the electrical rating of the appliance, and (2) the cord should be arranged so that it will not drape over the countertop or tabletop where it can be pulled on by children or tripped over unintentionally.



ADDITIONAL IMPORTANT SAFEGUARDS

CAUTION HOT SURFACES: This appliance generates heat and escaping steam during use. Proper precautions must be taken to prevent the risk of burns, fires, or other injury to persons or damage to property.

1. A person who has not read and understood all operating and safety instructions is not qualified to operate this appliance. All users of this appliance must read and understand this Owner's Manual before operating or cleaning this appliance.
2. **Unplug from outlet when not in use and before cleaning. To avoid electric shock, never immerse or rinse this appliance in water or any other liquid.**
3. If this appliance falls or accidentally becomes immersed in water, unplug it from the wall outlet immediately. **Do not reach into the water!**
4. When using this appliance, provide adequate air space above and on all sides for air circulation. Do not operate this appliance while it is touching or near curtains, wall coverings, clothing, dishtowels or other flammable materials.
5. To reduce the risk of fire, do not leave this appliance unattended during use.
6. If this appliance begins to malfunction during use, immediately unplug the cord. Do not use or attempt to repair a malfunctioning appliance!
7. The cord to this appliance should only be plugged into a 120V AC electrical wall outlet.
8. Do not use this appliance in an unstable position.
9. Do not use this appliance for other than its intended use.

ELECTRIC POWER

If electric circuit is overloaded with other appliances, your bread maker may not operate properly. The bread maker should be operated on a separate electrical circuit from other operating appliances.

POLARIZED PLUG

This appliance has a polarized plug (one blade is wider than the other). As a safety feature to reduce the risk of electrical shock, this plug is intended to fit in a polarized outlet only one way. If the plug does not fit fully in the outlet, reverse the plug. If it still does not fit, contact a qualified electrician. Do not attempt to defeat this safety feature.



POWER OUTAGE

During the Bread programs, if the bread maker loses power before the baking process begins, you may try starting the bread maker at the beginning of the program again for all programs except Fast Bake™. If using Dough program, you may also try starting it at the beginning of the program again. This may not always produce an acceptable loaf. If you are not sure when the outage occurred, remove the dough ball from the pan and place in an oven-safe baking container. Allow to double in size and place in a preheated 350°F/177°C oven for 30-45 minutes or until done. If it is done, the bread should sound hollow when tapped on the top of the loaf.

If you are using the Fast Bake™ program or if the bread has already begun to bake when the outage occurs, you must begin with new ingredients.

Should a power outage occur during the Dessert program, provided it has not begun to bake, you can try starting the program from the beginning. This may not always produce an acceptable result.

BEFORE YOUR FIRST USE

1. Please fill out warranty information.
2. Unpack and clean the Bread & Dessert Maker. See Cleaning and Storing.
3. Place the Bread & Dessert Maker away from edge of counter on a dry, stable surface away from burners and away from areas where cooking grease or water may splatter onto it. Avoid placing it where it may tip over during use.
4. Plug the Bread & Dessert Maker into a 120 V ~ 60 Hz outlet.



YOUR CORNER BAKERY BREAD & DESSERT MAKER

The illustrations in this Instruction Manual are for information purposes only. You may find your bread maker and parts look different, however, the steps for operation are the same.

1. Pan Handle
2. Kneading Blade
flat side down (P/N
55S866)
3. ▼ Front ▼
4. Bread Pan (P/N 55S867)
5. Shaft, rotates the
Kneading Blade
6. Inner Case
7. Handle
8. Lid (P/N 55S864)
9. Viewing Window
10. Air Exhaust
11. Control Panel

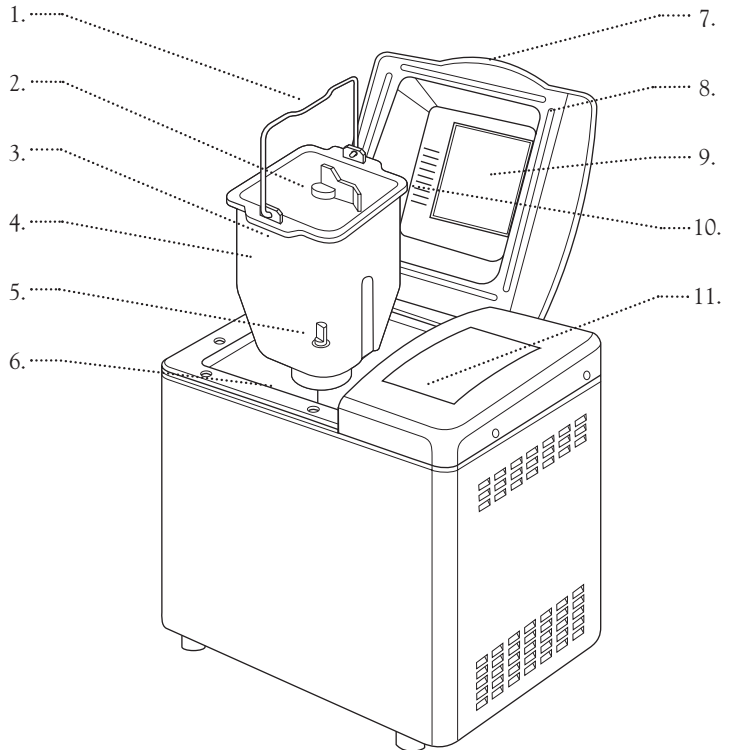

Accessories



Liquid Measuring Cup
(1 cup)
(P/N 22257)

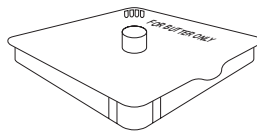

Butter Lid (Use this lid for
Butter program only.)
(P/N55S884)

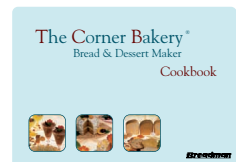

Cookbook for Breads,
Doughs, Butters and
Desserts (P/N 61218)



CONTROL PANEL

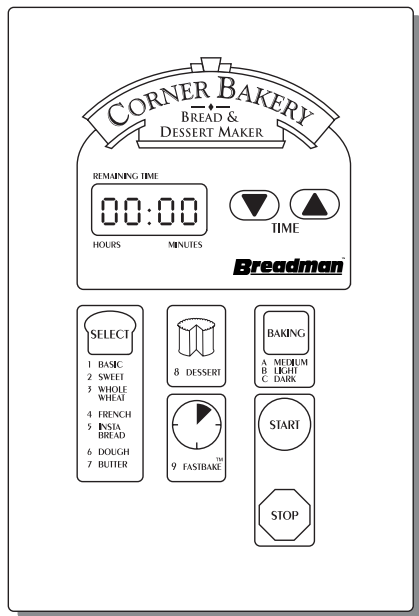

A. Display Window

Indicates the number of the program, crust color (if using programs 1-5) and amount of time left for completion of program. Indicates display signals.

B. SELECT

Press until program number is visible in Display Window for all programs except Dessert and Fast Bake™.

C. DESSERT

Press to select the Dessert program. The number 8 will be visible in the Display Window.

D. FAST BAKE™

Press to select the Fast Bake™ program. The number 9 will be visible in the Display Window.

E. ▼ ▲ TIME

Press arrows to delay program. The time will advance in 10 minute intervals up to 13:00 hours. Press the START button; the colon will blink. The timer cannot be used on Butter, Dessert or Fast Bake™ programs.

F. BAKING

Press to select light or dark crust color for Bread programs only; medium is preset. Use light crust for breads high in sugar.

G. START

After selecting the program, the baking control and timer (if needed), press to start the program or timer countdown.

H. STOP

Press and hold for more than 2 seconds during the cycle to cancel a program.

Note: When the Corner Bakery Bread & Dessert Maker is packaged for shipment, a clear plastic film is placed over the control panel; carefully peel it off.

I. Program Cancel

If you want to cancel the selected program, press the STOP button and hold it down for more than 2 seconds at any time during the cycle.

J. Program Select Recall

If you have started the Corner Bakery Bread & Dessert Maker and are not sure which program you have selected, you may recall this information. Press and hold the START button at any time. The number of the program and the crust color selection (if available) will be visible in the Display Window.



USING THE BREADMAN®

Before using the Breadman® for the first time, carefully read all of the instructions included in this manual.

With your new Breadman® Corner Bakery Bread & Dessert Maker:

- You can use commonly available pre-packaged bread mixes. Follow the instructions on the package.
- You can bake a loaf of bread from scratch. See the Corner Bakery Bread & Dessert Maker Cookbook included with your Breadman® Corner Bakery Bread & Dessert Maker for lots of tasty options.
- There are also many bread machine cookbooks available at bookstores nationwide.
- You can make dough for rolls or shaped loaves you'll bake in your own oven.
- Use the Dough Cycle to do the mixing and kneading for you, then shape, proof, and bake it in the Breadman® Corner Bakery Bread & Dessert Maker, or in a conventional oven.

Inserting and Removing the Bread Pan

- Insert the Bread Pan into the Oven Chamber. Press down until it locks into place.
- Remember to attach your Kneading Paddle **FIRST**, then add the ingredients **BEFORE** inserting the Bread Pan into the Oven Chamber.
- When you remove the Bread Pan after Baking, BE SURE TO WEAR OVEN MITTS to prevent burning. Hold the Handle and lift the Bread Pan up and out of the Bread Baker.
- Remove the loaf by turning the Bread Pan upside down and shaking gently, then check to see that the Kneading Paddle is removed from the loaf. If it is stuck in your bread, use a non-metal utensil to gently remove it, taking care not to scratch the Kneading Paddle.



USING THE BREADMAN® (CONTINUED)

Operating Tips

- Use oven mitts when working with bread or any part of the Breadman® that is hot from baking.
- Wipe off crumbs and clean the Breadman®, as needed, after baking.
- Unplug the Breadman® Corner Bakery Bread & Dessert Maker when you are not using it.
- **It is normal for the Viewing Window to collect moisture during the Rise Cycle.** As your food bakes, the moisture soon will evaporate so you can watch your bread's baking progress.

Caution

- Do not touch the Viewing Window during use. The Viewing Window gets very hot.
- **Don't open the Lid during Baking.** This causes baked products to bake improperly.
- **Don't unplug the Breadman® during Kneading or Baking.** This will stop the operation.
- You have Instant Recall™ Power Failure Back-Up. If the electricity in your home goes out, the Breadman® Corner Bakery Bread & Dessert Maker's memory stores the active program for up to 15 minutes.



USING THE BREADMAN® (CONTINUED)

Caution

- To protect young children, keep the Breadman® out of their reach when you're not there to supervise – especially during the Kneading and Baking Cycles.
- Use the Breadman® on a flat, hard surface. Don't place it near a flame or heat, or on a soft surface (such as carpet). Avoid placing it where it may tip over during use. Dropping the Breadman® could cause it to malfunction.
- To avoid burns, stay clear of the Steam Vent during Kneading and Baking. Also, do not touch the Viewing Window – it gets very hot.
- **ALWAYS HANDLE THE HOT BREAD PAN OR BAKING RACK WITH A POT HOLDER OR OVEN MITT.** After baking, wait for the Breadman® to cool down before touching or cleaning the Bread Pan, Baking Rack or internals of the Breadman® without oven mitts.
- Never use metal utensils with the Breadman®. These can scratch the non-stick surface of the Bread Pan.
- Avoid electric shock by unplugging the machine before using a damp cloth or sponge to wipe the interior of the Oven.
- Never use the Bread Pan on a gas or electric cooktop, on an open flame or in a microwave oven.
- Avoid covering the Steam Vent during Kneading and Baking Cycles. This could cause the Breadman® to warp or discolor.
- Always make sure the Kneading Paddle is removed from the bread prior to slicing.



KNEADING AND BAKING CYCLES

All Breadman® recipes tell you what program to select for each recipe. Refer to prepackaged bread mix directions to determine the program selection for each specific mix.

The Dessert program features a beep signal to check for proper mixing. The Fast Bake™ program features a beep signal to check the dough ball. The Sweet, Whole Wheat and Dessert programs contain beep signals to check the dough ball and/or add additional ingredients (i.e., raisins, nuts). Refer to program specification on page 10.

Program 1
Basic

- Use this program for basic bread recipes and most packaged bread mixes.

Program 2
Sweet

- This program works best if a recipe is high in sugar, fat, eggs or cheese.

Program 3
Whole Wheat

- If a recipe contains more than 50% whole wheat flour, use this program. During the first 20 minutes, the bread maker is preheating prior to first knead.

Program 4
French

- This program is best suited for breads low in fat and sugar, which results in a crisp crust and a coarse, chewy interior.

Program 5
Insta Bread

- Use this program on recipes indicated with a **5** in the Bread Index of the Corner Bakery Cookbook. Simply omit the amount of active dry yeast called for in the recipe and use the larger amount of active dry yeast listed for the Insta Bread program instead.

Program 6
Dough

- This program is used to prepare dough for making bread or rolls which are shaped before baking in a conventional oven.

Program 7
Butter

- The kneading blade churns the heavy whipping cream for 30 minutes. The heating element does not warm the inner case.

Program 8
Dessert

- This program will mix and bake/cook cakes, cheesecakes, pie fillings/puddings and fudge.

Program 9
Fast Bake™

- Use this program to make bread in less than one hour. The crust color is preset to medium. Simply use the special instructions and recipes found in the Corner Bakery Cookbook.



Process	P R O G R A M								
	1 - BASIC	2 - SWEET	3 - WHOLE WHEAT	4 - FRENCH	5 - INSTA BREAD	6 - DOUGH	7 - BUTTER	8 - DESSERT	9 - FAST BAKE™
1 - Delay timer	3:50 - 13:00	3:50 - 13:00	4:10 - 13:00	3:50 - 13:00	2:09 - 13:00	1:13 - 13:00	-	-	-
2 - Preheat	-	-	20 min	-	-	-	-	-	-
3 - Mix	2 min	2 min	2 min	2 min	2 min	2 min	-	2 min	2 min
4 - 1st knead	5 min	5 min	11 min	11 min	5 min	4 min	-	5 min	9 min
5 - Display time for beep to stir*	-	-	-	-	-	-	-	1:48	:53
6 - Rest	5 min	5 min	50 min	50 min	-	5 min	-	5 min	-
7 - 2nd knead	12 min	12 min	12 min	12 min	17 min	12 min	-	8 min	-
8 - Display time for beep to add**	-	3:25	2:34	-	-	-	-	1:20	-
9 - 1st rise	40 min	40 min	20 min	20 min	17 min	40 min	-	20 min	16 min
10 - Punch	4 sec	4 sec	4 sec	4 sec	4 sec	4 sec	-	-	-
11 - 2nd rise	26 min	26 min	15 min	15 min	8 min	-	-	-	-
12 - Punch	4 sec	4 sec	4 sec	4 sec	4 sec	-	-	-	-
13 - 3rd rise	60 min	60 min	40 min	40 min	30 min	-	-	-	-
14 - Bake/Cook	50 min	50 min	50 min	50 min	40 min	-	-	55 min	32 min
15 - Cool	20 min	20 min	20 min	20 min	-	-	-	20 min	-
16 - Churn	-	-	-	-	-	-	30 min	-	-
17 - End	[:H]	[:H]	[:H]	[:H]	[:H]	End	End	End	End
18 - Total	3:40	3:40	4:00	3:40	1:59	1:03	:30	1:55	:59
19 - Keep warm	3 hours	3 hour	3 hours	3 hours	3 hours	-	-	-	-

*The Dessert program will beep 2 times when the display reads 1:48 as a reminder to stir the ingredients. The Fast Bake™ program will beep when the display reads :53 to check the dough ball and scrape any ingredients from the sides of the pan.

**The Sweet, Whole Wheat and Dessert programs will beep to tell you when to check the dough ball and/or add additional ingredients, i.e. raisins or nuts, in specialty breads or when to add ingredients in desserts.



MAKING DOUGH AND BAKING BREAD

Programming

Note: Use plastic lid for Butter program only.

The following are the general steps for using your bread maker. Depending on the program or recipe you choose, some steps may not apply or there may be additional steps. Refer to the Bread, Fast Bake™, Dough, Butter and Dessert sections.

1. Add all ingredients to the pan in the order listed in the recipe.
2. For more detailed ingredient information or regular bread and dough instructions, refer to Corner Bakery Cookbook.
3. The Fast Bake™ program does not have a delay or hold warm feature.
4. The illustrations in this Use and Care Guide are for information purposes only. You may find your bread maker and parts look different, however, the steps for operation are the same.

STEP 1

Open the Lid and remove the Bread Pan by pulling straight up, using the Pan Handle.

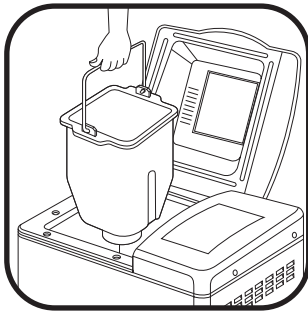

STEP 2

Attach the Kneading Blade onto the Shaft, flat side down.

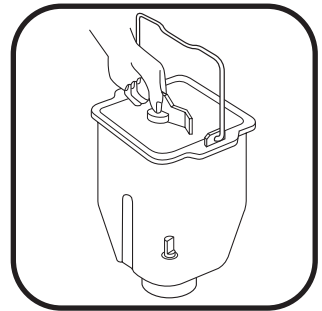



STEP 3

Place all ingredients in Bread Pan in the order listed.

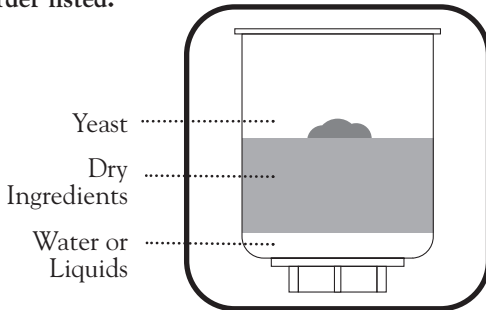

NOTE: *If using the Fast Bake™ program or delay timer, add all of the ingredients at the beginning. The ingredients will be chopped into smaller pieces.*

STEP 4

Insert Bread Pan until it fits securely into bottom of bread maker with the ▼ FRONT ▼ marking facing the front of the bread maker. This will provide a more even airflow during baking/cooking.

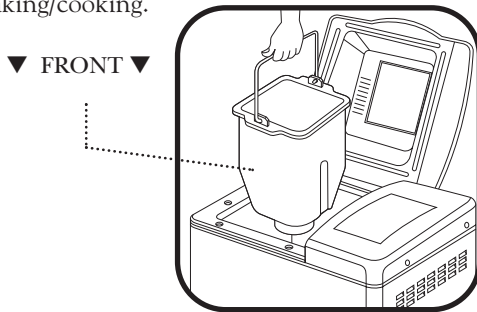

STEP 5

Close the Lid. Plug into 120 V ~ 60 Hz outlet. The display indicator will light up. Place bread maker away from edge of counter.

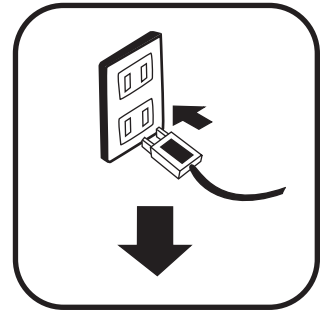

STEP 6

Select program and baking control. The **BAKING** function is used to select the bread crust color for all bread programs except Fast Bake™. It can be baked medium, light or dark. It is not necessary to press the control when medium is desired. Smaller size recipes and mixes will not fill the Bread Pan when finished.





STEP 7

Press START. The program time remaining is displayed and counts down. The Fast Bake™ program will beep as a reminder to check the dough ball. At this time, use a rubber spatula to scrape any ingredients from the sides of the Bread Pan. The Sweet and Whole Wheat programs will beep as a reminder to add additional ingredients during the second knead.

Opening the Lid will not stop kneading. Add ingredients quickly and evenly over dough to prevent heat loss. At this time also check the dough ball and use a rubber spatula to scrape any ingredients from the sides of the Bread Pan. **Close Lid.**



STEP 8

The bread maker will beep when bread or dough is done. Press **STOP** and remove the Bread Pan using oven mitts. If you do not stop the unit and remove the bread, it will automatically go into the keep warm function on all programs except Dough and Fast Bake™. During the keep warm function [:H] will be visible in the Display Window. Your bread will be kept warm for three hours and then the bread



maker will shut off. For best results, remove bread immediately after the bake process is complete. At the end of Dough and Fast Bake™, End will be visible in the Display Window.

STEP 9

Turn the Bread Pan upside down and shake several times to release the bread or dough.

Place the bread upright on a wire rack to cool 20-30 minutes before cutting.

This allows the steam to escape. Be sure to remove the Kneading Blade from the bread. Follow shaping and baking directions for dough.

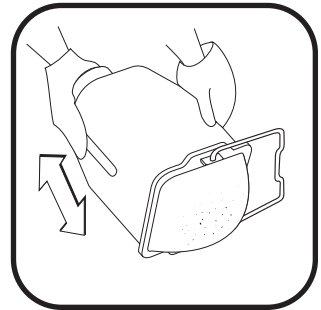

CAUTION: The Bread Pan, Kneading Blade and bread will be very hot. Always unplug after use. **Note:** The unit must be allowed to cool down between each use.



USING THE DELAY BAKE TIMER

13 Hour Delay Bake Timer

The delay timer can be set to delay bread making up to 13 hours. At the selected time, delicious bread will be ready. The delay timer works for all programs except Fast Bake™ Bread, Butter and Dessert.

Add all ingredients to the Bread Pan in the order listed. It is critical to add the yeast last, on top of the flour and away from the liquid. This will keep the yeast from activating until the bread maker starts to mix.

When delaying bread, reduce the amount of water by 1-3 teaspoons, depending on the size of loaf. Set the program and bread baking control. Before pressing the **START** button, set the timer for however long you want to wait before the bread is done.

Example: It is 9:00 p.m. now. The bread is to be ready at 6:30 a.m. the next morning. Set the timer for 9:30, because there are 9 hours and 30 minutes between 9:00 p.m. and 6:30 a.m.

STEP 1

When pressed, the time will advance in 10 minute increments.

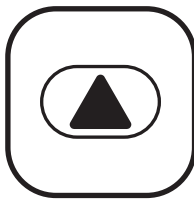

STEP 2

When constant pressure is applied to the button, the time will advance quickly.

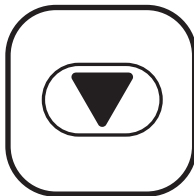

STEP 3

Press the **START** button. The timer is set, and the colon blinks. After one minute, 9:29 is displayed. The timer will continue to count down in 1 minute increments.

Note: The bread maker will start when the timer has counted down to the start time for the program to begin.





BUTTER

The Butter program does not have a delay feature.

For more detailed ingredient information and butter instructions refer to the Corner Bakery Cookbook.

Note: Use plastic lid for Butter program only.

STEP 1

Open the Lid and remove the Bread Pan by pulling straight up, using the Pan Handle.



STEP 3

Pour heavy whipping cream in Bread Pan. Place Butter Lid on Bread Pan. Use Butter Lid for Butter program only.

HEAVY
WHIPPING
CREAM

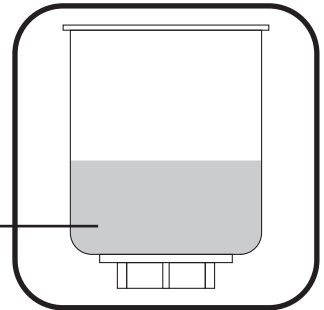

STEP 2

Attach the Kneading Blade onto the Shaft, flat side down.

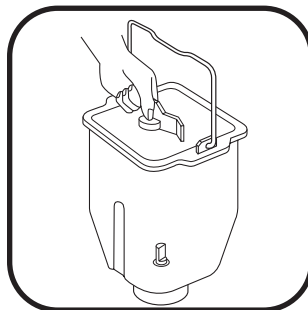

STEP 4

Insert Bread Pan until it fits securely into bottom of bread maker with the ▼ FRONT ▼ marking facing the front of the bread maker. This will provide more even air-flow.

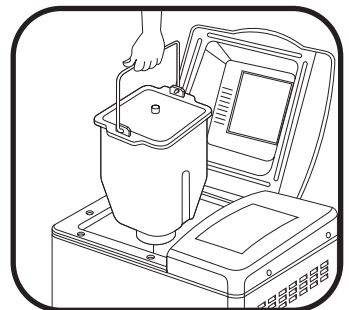



STEP 5

Close the Lid. Plug into 120 V ~ 60 Hz outlet. The Display Window will light up.

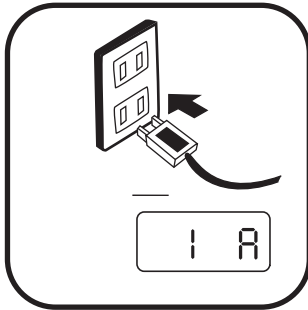

STEP 6

Select Butter program.

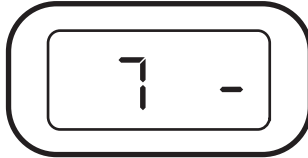

STEP 7

Press the START button. The program time remaining is displayed and counts down.

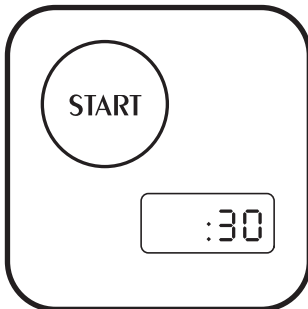

STEP 8

The bread maker will beep when butter is done. Press the STOP button and remove the Bread Pan.



STEP 9

Without removing Butter Lid, tilt the Bread Pan, pouring the buttermilk off the butter. Remove Butter Lid and pour one cup of cold water into the Bread Pan and replace Lid. Tilt Bread Pan to drain water from butter and repeat. Remove butter from Bread Pan using a rubber or plastic spatula.

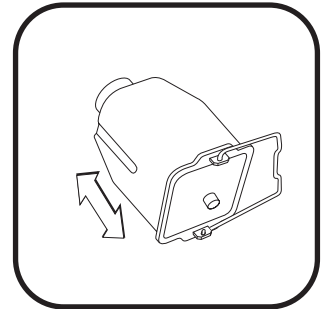

CAUTION:
Always unplug after use.



DESSERT

Programming

The Dessert program does not have a delay feature.

For more detailed ingredient information and dessert instructions refer to the Corner Bakery Cookbook.

Note: Use *Butter Lid* for *Butter* program only.

STEP 1

Open the Lid and remove the Bread Pan by pulling straight up, using the Pan Handle.

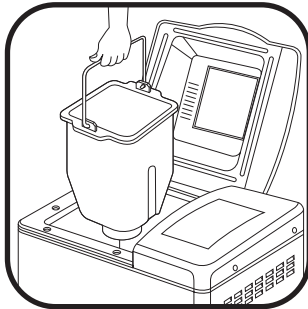

STEP 3

Place all ingredients in Bread Pan in the order listed. No mixing of ingredients outside the machine is necessary.

Dry
Ingredients
Liquids

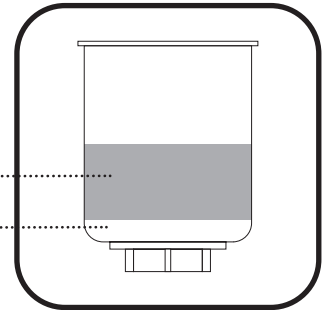

STEP 2

Attach Kneading Blade onto the Shaft, flat side down.

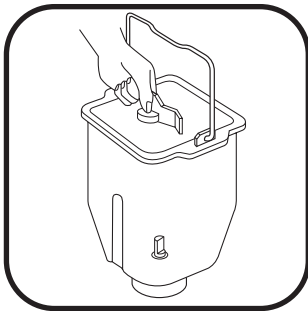

STEP 4

Insert Bread Pan until it fits securely into bottom of bread maker with the ▼ FRONT ▼ marking facing the front of the bread maker. This will provide a more even air-flow during baking/cooking.

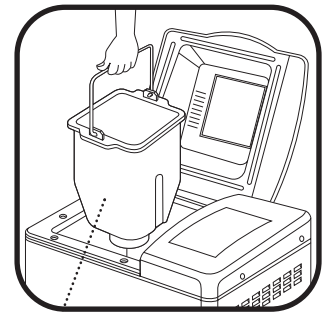

▼ FRONT ▼



STEP 5

Close the Lid. Plug into 120 V ~ 60 Hz outlet. The Display Window will light up.

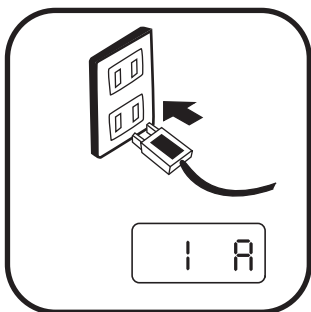

STEP 6

Press DESSERT button. Place bread maker away from edge of counter.

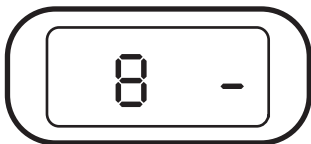

STEP 7

Press START. The program time remaining is displayed and counts down. When the Display Window reads 1:48, the machine will beep 2 times and stop mixing. Take a rubber spatula and scrape the dry ingredients from the top sides and bottom corners of the Bread Pan

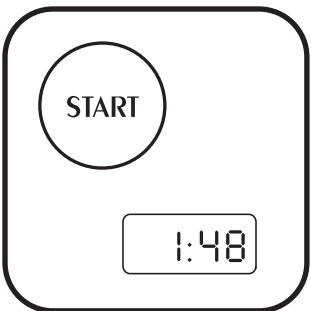

into the wet mixture. At 1:43 mixing will resume. When the Display Window reads 1:20, it will beep 4 times as a reminder to add additional ingredients. Add ingredients quickly and evenly over batter to prevent heat loss. Close Lid.

STEP 8

The bread maker will beep when dessert is done. Press **STOP** and remove the Bread Pan using oven mitts for all desserts except cheesecakes. See special instructions for cheesecakes in the Corner Bakery Cookbook.



STEP 9

Place the Bread Pan on a heat resistant surface. Refer to the Corner Bakery Cookbook for additional mixing, cooling and removing instructions.

CAUTION: The Bread Pan, Kneading Blade and dessert will be very hot. Always unplug after use.

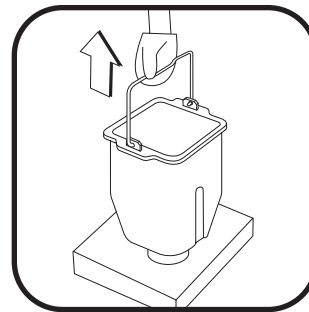



CLEANING INSTRUCTIONS

CAUTION: Always unplug the bread maker and allow to cool completely before cleaning. Carefully unpack the bread maker and remove all packaging materials.

Clean-up of bread maker

1. Unplug and allow to cool before cleaning.
2. Remove the Bread Pan from inside the bread maker.
3. Clean exterior of bread maker with a damp cloth and plastic scouring pad if necessary. Do not rub too hard as the surface may become scratched.
4. Remove any flour, bread crumbs or other food from the inside of the oven cavity using a damp sponge, cloth or a small portable vacuum cleaner. A plastic scouring pad may be used if necessary. Do not rub too hard as the surface may become scratched.
5. To clean the glass in the Lid, use a glass cleaner or mild detergent and a damp cloth or plastic scouring pad. Do not use an abrasive cleaner or pad as they might scratch the glass.
6. Rinse with a damp cloth and dry thoroughly.

Clean-up of bread pan and kneading blade

CAUTION: Do not immerse Bread Pan or wash in dishwasher.

1. Allow to cool before cleaning.
2. Fill with hot soapy water and remove Kneading Blade. If necessary to remove the Kneading Blade from the Bread Pan, allow the soapy water to remain in the pan for up to 30 minutes (longer times may damage the non-stick surface). It is not necessary to remove the Kneading Blade for cleaning, but if you wish to, it must be removed after each use otherwise it will become very difficult to remove.
3. Wash Bread Pan and Kneading Blade with a nylon bristle brush. Do not use steel wool, abrasive cleaners or metal utensils on the Bread Pan or Kneading Blade as they will damage the non-stick surface. Normal wear is to be expected. The non-stick may discolor over time but that in no way affects performance.



STORING

- All removable parts should be thoroughly cleaned and dried.
- Store bread maker with Kneading Blade inside Bread Pan and Lid closed.

TROUBLESHOOTING

Bread and Dough

Symptom	Possible Solution
Why does the height and shape of bread differ in each loaf?	The height and shape of bread may differ depending on the ingredients, room temperature and length of the timer cycle. Also, accurate measurement of ingredients is essential to make delicious bread.
The bread has an unusual aroma. Why?	Stale ingredients or too much yeast may have been used. Always use fresh ingredients. Accurate measurements are essential to make delicious bread.
The Kneading Blade comes out with the bread.	This can happen as the Kneading Blade is detachable. Use a non-metal utensil to remove it. Caution: The Kneading Blade will be hot.
The baked loaf of bread has a floured corner.	Sometimes flour in the corner of the Bread Pan may not have been completely kneaded into the dough. Scrape the flour off the loaf with a spatula.
Why can the timer not be set for more than 13 hours?	Longer delay times could alter the baking results.
Can ingredients be halved or doubled?	No. If there is too little in the Bread Pan, the Kneading Blade cannot knead well enough. If there is too much, bread swells out of the Bread Pan.
Can fresh milk be used in place of dry milk?	Yes, in all programs except Fast Bake™. Be sure to deduct the same measurement of water to equal liquid substitution (warm to 80°F/27°C). Fresh milk is not recommended when using the timer, because it may spoil while sitting in the pan.



Dessert

Symptom	Possible Solution
Why does the height and shape of the desserts vary?	The height and shape of desserts may differ depending on the ingredients. Accurate measurement of ingredients is essential to make delicious desserts.
The Kneading Blade comes out with the dessert.	This can happen as the Kneading Blade is detachable. Use a non-metal utensil to remove it.
The dessert has a floured corner.	Be sure to stir the dessert when it beeps two times at 1:48.
Can the timer be used?	No, the ingredients will not mix and bake properly. Most of the recipes have perishable ingredients and you must stir the ingredients with 1:48 remaining.
Can ingredients be halved or doubled?	No. If there is too little in the Bread Pan, the Kneading Blade cannot mix well enough. If there is too much, the Bread & Dessert Maker will not cook the dessert properly.
Can fresh milk be used in place of dry milk?	Yes. Be sure to deduct the same measurement of water to equal liquid substitution.
Do I have to use egg replacement in the filling and pudding recipes?	Yes, egg replacement must be used because eggs will curdle when making these recipes.



Bread and dough ✓check list

Baking results:

- A. Bread maker does not operate/ingredients not mixing
- B. Smoke emitted from steam vent/burning smell
- C. Sides of bread collapse/bottom is damp
- D. Bread rises too much/coarse texture
- E. Bread falls/coarse texture
- F. Short & dense texture
- G. Slices uneven & sticky



		A.	B.	C.	D.	E.	F.	G.
OPERATIONAL ERRORS	✓Check list:							
	1. Unplugged/power outage	x						
	2. Oven area is too hot (HI)	x	x					
	3. Oven area is too cold	x						
	4. Display reads: E:02, E:03, E:04, E:05, E:08	x						
	5. Ingredients spilled on heating element		x					
	6. Top Lid was open during baking					x	x	
	7. Bread left in Bread Pan too long after program							
	8. Bread sliced just after baking (steam was not allowed to escape)							x
	9. Whole Wheat program chosen	x						
10. Kneading Blade not installed	x							
INGREDIENT PROBLEMS	MEASUREMENT ERRORS	Water	11. Not enough					x
			12. Too much					
		Flour	13. Not enough		x		x	
			14. Too much					x
	Yeast	15. No yeast						x
			16. Not enough					x
			17. Too much			x	x	
		18. No sugar, molasses or honey						x
		19. Ingredients used other than recommended				x	x	x
	Flour	20. Wrong type of flour used						x
	Yeast	21. Yeast touched water before kneading						x
		22. Old yeast used						x
		23. Wrong type of yeast						x
	24. Temperature of liquid either too hot or too cold						x	



SUGGESTIONS

The following suggestions have a corresponding number found on the check list on the previous page. Be sure to read both.

1. Plug into 120 V ~ 60 Hz outlet. Refer to power outage instructions.
- 2-3. Open Lid, remove Bread Pan and allow to cool or warm up.
4. Needs service.
5. Wait until program is complete; unplug, allow to cool and clean.
6. Only open Lid during kneading process to check dough ball or to add ingredients.
7. Remove bread as soon as program is done and place on wire rack.
8. Allow to cool approximately 20 minutes.
9. Programs begin with preheat. No movement occurs in the Bread Pan.
10. Put Kneading Blade on the shaft of Bread Pan.
- 11-14. Check the dough ball at the beep. Each dough ball, except those prepared in Fast Bake™ should be round, smooth-textured, soft and slightly tacky to the touch. When touched, the dough ball will leave a little dough on your finger. Fast Bake™ dough ball will be sticky to the touch. When touched, it will leave dough on your finger. If more like a batter, add 1 TBL flour. Allow to mix; add more if necessary. If too dry, add 1 tsp water. Allow to absorb; add more if necessary.
15. Follow recipe.
16. Increase by ¼ tsp.
17. Decrease by ¼ tsp.
18. Artificial sugar substitutes are not recommended.
19. Follow recipe or substitution recommendations.
20. Flours cannot be substituted.
21. Place yeast on top of flour away from liquids.
22. Make sure yeast is fresh and room temperature.
23. For all programs, except Fast Bake™, use active dry/rapid or Quick•Rise™ yeast in equal amounts. Follow bread maker yeast directions. See Fast Bake™ directions.
24. Liquid temperature should be 80°F/27°C for all programs except Fast Bake™ which should be 110-115°F/43°-46°C.



IN-WARRANTY SERVICE INFORMATION

Please refer to warranty statement to determine if in-warranty service applies. This appliance must be serviced by a Breadman® authorized service center. Unauthorized service will void warranty.

If an authorized service center is not available locally, your appliance may be returned, postage prepaid, to our National Service Center at the address shown in the back of this book. Call Consumer Service for return authorization.

Products must be adequately protected to avoid shipping damage. Surround your appliance with three inches of protective padding and include a copy of your dated sales receipt and a note explaining the problem you have experienced. We recommend insuring your package. No CODs accepted.

Keep Dated Sales Receipts for Warranty Service.

Keep this booklet. Record the following for reference:

Date purchased _____

Model number _____

Date Code (stamped on bottom) _____



SPECIFICATIONS

Power supply	120 V ~ 60 Hz
Heater	430W
Kneading Motor	75W
Dimension (WxDxH)	13½" x 10" x 13½"
Weight	Approx. 19 lbs.

LIMITED ONE YEAR WARRANTY

Warranty: This Breadman® product is warranted by Salton, Inc. to be free from defects in materials or workmanship for a period of (1) year from the original purchase date. This product warranty covers only the original consumer purchaser of the product.

Warranty Coverage: This warranty is void if the product has been damaged by accident in shipment, unreasonable use, misuse, neglect, improper service, commercial use, repairs by unauthorized personnel, normal wear and tear, improper assembly, installation or maintenance abuse or other causes not arising out of defects in materials or workmanship. This warranty is effective only if the product is purchased and operated in the USA, and does not extend to any units which have been used in violation of written instructions furnished with the product or to units which have been altered or modified or to damage to products or parts thereof which have had the serial number removed, altered, defaced or rendered illegible.

Implied Warranties: ANY IMPLIED WARRANTIES WHICH THE PURCHASER MAY HAVE ARE LIMITED IN DURATION TO ONE (1) YEAR FROM THE DATE OF PURCHASE. Some states do not allow limitations on how long an implied warranty lasts, so the above limitation may not apply to you.

Warranty Performance: During the above one-year warranty period, a product with a defect will be either repaired or replaced with a reconditioned comparable model (at our option) when the product is returned to the Repair Center, or the purchase price refunded. The repaired or replacement product will be in warranty for the balance of the one-year warranty period and an additional one-month period. No charge will be made for such repair or replacement.

Service and Repair: Should the appliance malfunction, you should first call toll-free 1 (800) 233-9054 between the hours of 9:00 am and 5:00 pm Central Standard Time and ask for CONSUMER SERVICE stating that you are a consumer with a problem. Please refer to model number TR888 when you call.

In-Warranty Service (USA): For an appliance covered under the warranty period, no charge is made for service or postage. Call for return authorization 1 (800) 233-9054.

Out-of-Warranty Service: A flat rate charge by model is made for out-of-warranty service. Include \$15.00 (U.S.) for return shipping and handling. We will notify you by mail of the amount of the charge for service and require you to pay in advance for the repair or replacement.

For Products Purchased in the USA, but Used in Canada: You may return the product insured, packaged with sufficient protection, and postage and insurance prepaid to the USA address listed below. Please note that all customs duty / brokerage fees, if any, must be paid by you and we will require you to pay the cost of customs duty / brokerage fees to us in advance of our performing any service.

Risk During Shipment: We cannot assume responsibility for loss or damage during incoming shipment. For your protection, carefully package the product for shipment and insure it with the carrier. Be sure to enclose the following items with your appliance: any accessories related to your problem, your full return address and daytime phone number, a note describing the problem you experienced, a copy of your sales receipt or other proof of purchase to determine warranty status. C.O.D. shipments cannot be accepted.

To return the appliance, ship to:

Attn: Repair Center
Salton, Inc.
708 South Missouri Street
Macon, MO 63552

To contact us, please write to or call:

Salton, Inc.
P.O. Box 7366
Columbia, MO 65205-7366
1 (800) 233-9054
E-mail: Salton@Saltonusa.com

Limitation of Remedies: No representative or person is authorized to assume for us any other liability in connection with the sale of our products. There shall be no claims for defects or failure of performance or product failure under any theory of tort, contract or commercial law including, but not limited to negligence, gross negligence, strict liability, breach of warranty and breach of contract. Repair, replacement or refund shall be the sole remedy of the purchaser under this warranty, and **in no event shall Salton be liable for any incidental or consequential damages, losses or expenses.** Some states do not allow the exclusion or limitation of incidental or consequential damages, so the above limitation or exclusion may not apply to you.

Legal Rights: This warranty gives you specific legal rights, and you may also have other rights which vary from state to state.

For more information on Salton products: visit our website: www.breadman.com, or email us at: breadman@saltonusa.com or eSalton.com



IMPORTANT NOTICE

*If any parts are missing or defective,
DO NOT return this product.
Please call our Consumer Service Department for assistance.*

800-233-9054 Monday—Friday 8am—5pm CST
Thank you



If, after reading this instruction booklet, you still have questions about using the Breadman® Corner Bakery Bread & Dessert Maker, please write or call:

Salton, Inc.
P.O. Box 7366
Columbia, MO 65205-7366
1-800-233-9054
Monday—Friday 8am—5pm CST

For more information on Salton, Inc. products, E-mail us at:

breadman@saltonusa.com
OR, visit our website:
<http://www.breadman.com>
or www.eSalton.com