

BRAUN

Series 7

7系



电动剃须刀

790cc

Type 5692

型号 5692

www.braun.com

790 cc-4

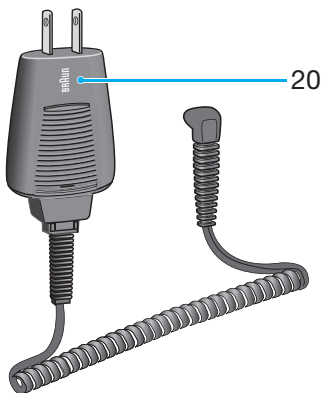
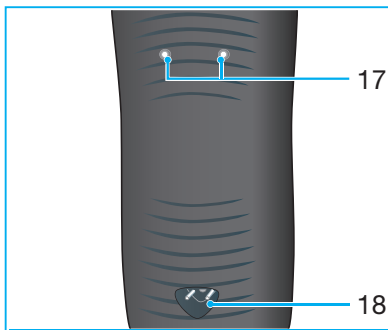
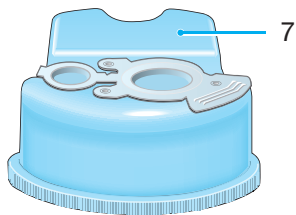
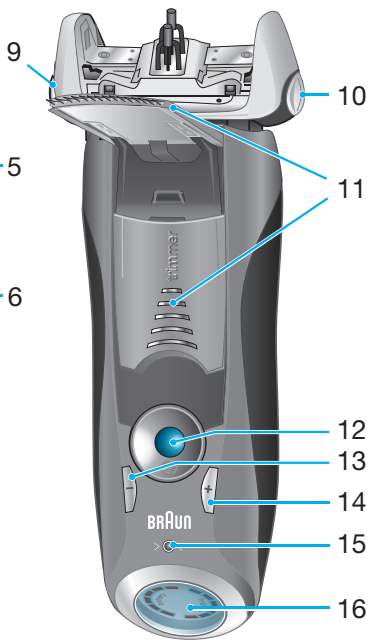

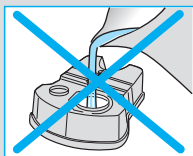
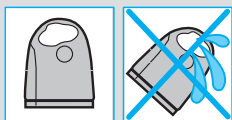
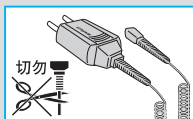

本产品设计优异、功能完善、质量可靠，满足高标准要求。希望您对新款博朗剃须刀感到满意。

使用产品前请仔细阅读使用说明书，并请妥善保管。

警告

本剃须刀提供的专用电源带有特别的安全低电压转换器。切勿更换或改装其中的任何部件，否则有触电危险。

在无监护人看管的情况下，儿童、行动不便或智力障碍的人不宜使用本产品，一般建议本产品应放在儿童不能触及的地方。通常我们建议您将本产品置于儿童触碰不到的地方。应监督儿童并确保他们不会把本产品当作玩具。

为避免清洁剂漏洒，请务必将自动清洁/充电器放置于平稳表面上。安装清洁剂盒后，切勿倾斜、晃动或长距离移动，以免清洁剂漏洒。请勿将博朗自动清洁/充电器置放于浴室镜柜内、取暖器、光滑或油漆的表面上。

清洁剂盒内含有高度易燃液体，应远离火源和放射源。并避免阳光直射或燃着的香烟。

请勿自行充装清洁剂盒，应使用博朗原装清洁剂。

组件说明

自动清洁/充电器

- ① 清洁液容量显示面板
- ② 清洁剂更换按钮
- ③ 清洁/充电器 - 剃须刀接口
- ④ 启动清洁按钮
- ④a 快速清洁按钮
- ⑤ 清洁程序指示灯
- ⑥ 清洁/充电器电源插口
- ⑦ 清洁/充电器清洁液盒

剃须刀

- ⑧ 网膜及刀头组合
- ⑨ 网膜松解按钮
- ⑩ 刀头锁定开关
- ⑪ 长须修剪器

- ⑫ 启动开关
- ⑬ 轻柔剃须(-)设定按钮
- ⑭ 强力剃须(+)设定按钮
- ⑮ 复位按钮
- ⑯ 剃须刀显示屏
- ⑰ 剃须刀-清洁/充电器接口
- ⑱ 剃须刀电源插口
- ⑲ 旅行包
- ⑳ 专用电源线



剃须前

首次使用前，应使用专用电源线⑳将剃须刀连接到电源插座，或按照以下步骤进行操作：

安装自动清洁/充电器

- 用专用电源线⑳将清洁/充电器⑥连接到电源插座。
- 按下更换按钮②打开清洁/充电器外壳。
- 将清洁剂盒⑦放置在水平、稳定的平面上(如桌面)。
- 小心打开清洁剂盒盖。
- 将清洁剂盒平滑推入清洁/充电器底座的最里面。
- 缓慢关上外壳直至锁紧。

清洁液容量显示面板①会显示清洁剂盒中的容量：

-  至多可进行30次清洁
-  至多还剩7次清洁
-  需更换新盒

对剃须刀进行充电及清洁

将剃须刀头向下插入清洁/充电器。(剃须刀背面的接口⑰需对准清洁/充电器的接口③)。

清洁/充电器此时根据需要进行充电，并分析剃须刀的卫生状况。清洁程序指示灯⑤之一会亮起：

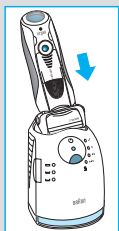
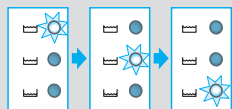
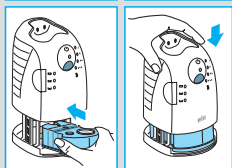
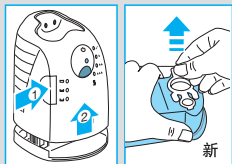
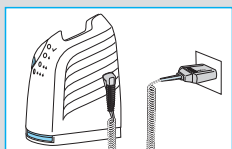

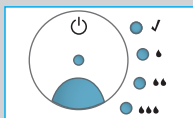

干净«✓» 剃须刀处于干净状态
 经济«1滴» 需简单清洁
 常规«2滴» 需常规清洁
 高强«3滴» 需高强度清洁

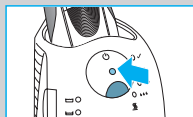

清洁/充电器选择了任意所需程序后，需按下启动清洁按钮④，清洁才会开始。为获得理想的剃须效果，建议每次剃须后都进行清洁。

清洁过程中所对应的指示灯会不断闪烁。每种清洁进程包含清洗液冲洗刀头、加热烘干等几次反复。基于不同的清洁程序，整个清洁过程耗时从32分钟至43分钟不等。

清洁程序不宜中断。请注意，烘干过程中刀头可能潮湿且发烫。清洁结束后，蓝色指示灯«✓»会亮起。此时剃须刀已洗净待用。

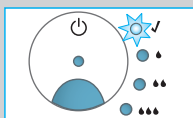

快速清洁

若您没有足够时间来等待上述任何一种自动清洁程序完成，可按下快速清洁④按钮，启动无烘干快速清洁程序。此程序只需25秒便可完成。若在此程序结束之后立即抽出剃须刀，应用纸巾将剃须刀头擦干，以避免液体滴落。

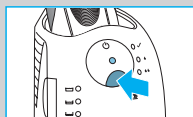

待机模式

完成充电或清洁程序10分钟后，清洁/充电器切换至待机模式：清洁/充电器上的指示灯将全部熄灭。

剃须刀显示屏

剃须刀显示屏⑥左侧显示电池电量状态，右侧显示剃须刀清洁状态(当电量充足，且剃须刀洁净时，两侧各显示6格。)



电量格：

剃须刀充电或使用过程中，对应的电量格会不断闪烁。若电量充足会显示6格。其数量会随着电量的减少逐渐减少。



低电量指示灯：

低电量 «low» 指示灯伴有红光闪烁时，则表示电量低于20%。所剩电量只能维持2-3次的剃须过程。

清洁状况指示灯：

在剃须刀经清洁/充电器清洁后，会显示6格。其数量会随剃须刀的使用而逐渐减少。在将剃须刀插回清洁/充电器后，清洁/充电器会自动选择合适的清洁程序，且最终清洁状况格指示灯会呈全满状态。鉴于自来水冲洗剃须刀的效果不如清洁/充电器，所以，仅在使用清洁/充电器清洁剃须刀后，清洁指示灯才会恢复到全满。

充电信息

- 电池充满后，在不外接电源线状态下至多可使用50分钟，具体时间须视胡须浓密程度而定。
- 最佳的充电环境温度为5°C至35°C之间。请勿长时间将剃须刀暴露于50°C以上的环境中。

个性化的剃须设计

个性化的剃须设计

使用轻柔剃须 (-) 按钮⑬和强力剃须 (+) 按钮⑭，您可依照个人需要对脸部的不同区域进行刮剃。具体的设定状态，由集成在开关⑫上的操控灯进行显示：

- 深蓝色 (高功率剃须)
- 浅蓝色 (一般剃须)
- 白色 (专门贴合您面部的敏感区域如颈部，带来彻底的舒适感受)



想要快速、彻底地进行剃须，建议您将设定调至强力剃须(+)。

当您下次再使用时，会自动使用您上次所设定的状态。

使用方法

按下启动开关⑫，使用剃须刀：

- 贴面感应刀头及浮动网膜将根据您的面部轮廓自动调整。
- 遇到难以剃及的区域时(如鼻子下方)，可将刀头锁定«lock»按钮⑩滑至后方位置，将贴面感应刀头锁定在一定的角度上，以便于对难及部位进行剃刮。
- 修剪鬓角、上胡须、络腮胡时，可向上弹出长须修剪器进行操作。

理想剃须的秘诀

为确保理想剃须效果，博朗特推荐剃须三步骤：

1. 洗脸之前剃须。
2. 剃须刀尽量与肌肤垂直(90°)。
3. 拉伸脸部肌肤，逆着胡须生长方向剃刮。

在外接电源的状态下进行剃须

若剃须刀电量耗尽，且没有时间通过清洁/充电器进行充电，则可使用专用电源线接电剃须。

清洁

自动清洁

每次使用后，将剃须刀置于清洁/充电器上，并依照前述«剃须前»一节的介绍操作。清洁/充电器会自动进行充电和清洁。日常使用情况下，一盒清洁剂足够清洗约30次。

清洁剂含有酒精，一旦打开，即会缓慢蒸发。如非每日使用，应大约8周更换一次。

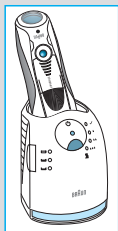
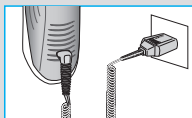
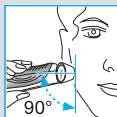
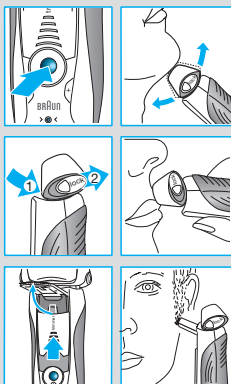

清洁剂也含有润滑油，可能于清洁后残留在刀网上。但用布或纸巾轻轻擦拭，便可清除。

手动清洁



本产品刀头可直接用自来水冲洗。

注意：清洗刀头前，应将剃须刀与电源线分离。

用自来水清洁刀头是保持剃须刀清洁的替代方法，尤其是在旅游期间：

- 启动剃须刀(请先拔掉电源线),⑫用自来水清洁刀头，或用不含颗粒或研磨物质的天然香皂清洗。冲去所有泡沫后保持剃须刀运转几秒钟。
- 关闭剃须刀，按网膜松解按钮⑨卸下网膜和刀头组合⑧，并将各零件晾干。
- 若经常用水冲洗剃须刀，应每周在网膜及刀头顶端滴少许轻机油。

可使用配置的小毛刷清洁剃须刀：

- 关闭剃须刀。卸下网膜和刀头组合⑧，在水平桌面上轻轻磕出须渣。用毛刷清洁贴面感应刀头内部区域，但不要用于毛刷清洁网膜，以免损坏。

清洁外壳

需定期使用湿布清洁剃须刀清洁/充电器的外壳，尤其是插入剃须刀的部位。

更换清洁剂

按下更换按钮②，打开外壳，稍等片刻后取出用过的清洁剂盒，以免液体洒漏。

用过的清洁剂盒内的清洁剂已被污染，丢弃前务必用新清洁剂盒的盖子将其盖紧。

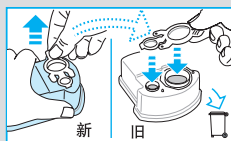
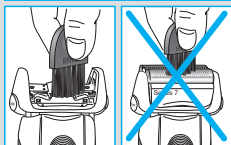
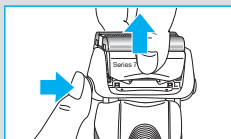
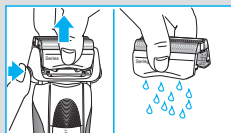
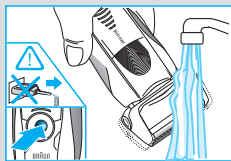

保持剃须刀理想状态

更换网膜及刀头组合/复位

为获得理想剃须效果，当剃须刀显示屏⑯上的更换指示灯亮起(约在18个月后)，或零件发生磨损时，应当更换网膜及刀头组合⑧。

更换指示灯会连续7次在剃须时提醒更换零件，而后自动复位原显示。

更换网膜及刀头组合后，用圆珠笔按压复位按钮⑮3秒钟以上，进行手动复位。

操作时，更换指示灯闪烁，完成复位后，即熄灭。手动复位可随时进行。

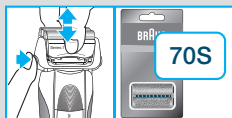

附加设备

经销商或博朗售后服务中心可以提供：

- 网膜及刀头组合70S
- 清洁剂盒、清洁/充电器 CCR



环保注意事项

本产品内包含可充电电池。为了保护环境，弃置产品时请勿与生活垃圾一起丢弃。当产品达到使用寿命后，弃置产品时请交至博朗服务中心或国家指定的回收站。



内置充电电池含有可能污染环境的物质。丢弃剃须刀时，请将电池取出，取出前请确认电池电量已完全耗尽。

请按图示步骤取出电池，如果您决定废弃剃须刀又不想自行分解机器取出电池，您也可以将剃须刀送到博朗服务中心，中心的员工会帮您取出电池并以最环保的方式处理它。

请勿分解取出的充电电池，可能引起火灾、触电及受伤。

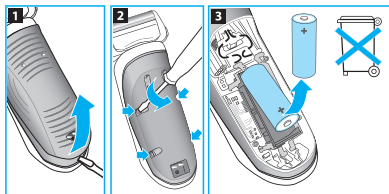

本说明可能在不事先通知的情况下做出修改。

电气规格详见专用电源线标示。

电动剃须刀

790cc

型号 5692

www.braun.com

广州宝洁有限公司

广州市经济技术开发区滨河路一号

邮 编：510730

原产国：德国

Braun是德国博朗公司(BraunGmbH)的注册商标。经德国博朗授权制造

保修

本产品保修期为购买之日起两年。保修期内凡因原材料或生产过程导致的各种瑕疵，本公司将视情况更换零件或整个产品。

本保修条款适用于所有博朗公司或其指定经销商销售本产品的国家。

上述保修承诺不适用于下述情形：

- 使用不当造成的产品损坏(包括但不限于使用错误的电流、电压，将产品插入不适合的插座及其他人为损坏)。
- 网膜和刀头损坏。
- 对正常使用影响不大的瑕疵。
- 非家庭使用(如工业、商业用)引起的损坏。

一旦由未获授权人员修理、或换用非博朗的原装零配件，本保修立即终止。

保修期内提供的服务不影响保修期的按时终止。保修期中替换的零件或整机的保修服务，与本产品的保修期同时终止。

本保修不影响法律明文规定的权利。

如需保修或维修，请携带整机和购买发票，与当地或就近的维修站联系。

顾客免费热线： 800 820 1357

最新Braun售后服务部地址

城市	公司名称	地址	联系电话
中区			
200085	上海 安帮北站天路家用电器维修服务社	上海市永兴路540号(靠近西藏北路)	63566755/56329466
200235	上海 乐帮新粤办公设备维修服务社	上海市漕溪路190号(靠近田林东路)	64688241
201100	上海 上海市闵行区博杰家用电器维修部	上海市闵行区莘建东路210号(莘庄地铁站-北广场)	64122533
310016	杭州 杭州中侨家电维修服务有限公司	杭州市采荷路10号	86047438
215004	苏州 苏州家用电器维修服务中心有限公司	苏州市干将西路1168号	68662852
266071	青岛 青岛市市南区超维影视通讯技术服务部	青岛市市南区银川西路3号政泰商务楼202室	85977910
361003	厦门 厦门市思明区新鹭声电子技术服务部	厦门市后埭溪路248号之6、7、8号	5170118
210003	南京 南京博伊华电子电器经营部	南京市中山北路223号建达大厦	83420092
214031	无锡 无锡新讯通信设备服务有限公司	无锡市五爱北路27号	82729805
213001	常州 常州市金博家电经营部	常州市天宁区迎宾路江南佳园4-S-10	88836628
226001	南通 南通市崇川雷声电器服务中心	南通市虹桥路怡安花苑11幢04店面	96889688/85102088
315040	宁波 宁波市江东明楼雨城家电维修部	宁波市江东南路506号	87771344
315000	宁波 宁波海曙创佳数码家电维修部	宁波市苗圃路39弄50号(海关对面)	87134422
250013	济南 济南市天桥区启航家电维修部	济南市历下区历山路57号历山商务中心407室	86950100
230022	合肥 合肥国升数码技术服务部	合肥市金寨路93号鸿基国际广场529室	2655887/2654456
450000	郑州 郑州百川电器技术有限公司	郑州市北下街79号	66964036
北区			
100078	北京 北京盛侨家用电器维修服务中心	北京市丰台区方庄芳群园2区6号楼金芳公寓408室	67698025/67630617
100035	北京 北京盛侨家用电器维修服务中心	北京市西城区德胜门内大街54号	66561976
050021	石家庄 河北省家电维修中心	石家庄市槐北路70号	86011793
300022	天津 天津市大东电器维修有限公司	天津市和平区滨江道109号	27120167
300100	天津 天津市大东电器维修有限公司	天津市南开区三马路126号	27120168 /27120170
110011	沈阳 沈阳市今东业家电技术服务有限公司	沈阳市沈河区承德路36-1	24870309/24855340
150010	哈尔滨 哈尔滨市道里区信誉进口家电维修部	哈尔滨市道里区地段街190号	84644674
150020	哈尔滨 哈尔滨市道外区尼康映像数码维修站	哈尔滨市道外区南勋街18号	88940125
116021	大连 大连中服电子技术服务中心	大连市沙河口区西南路791号-7-3	86841988
130021	长春 长春市朝阳区圣炎夏普维修站	长春市工农大路28号(桂林路与富锦路交汇)	85625783
130000	长春 南关区鑫昌行声光科技商行	长春市南关区卫星路卫星嘉园13栋3单元205门市	85399851
710014	西安 陕西百利商贸有限公司	西安市丰禾路6号丰禾小区22号楼2楼	86220211
南区			
510600	广州 广州市博健电器有限公司	广州市五羊新城明月二路春风路E-12栋首层	87386165(6)
518028	深圳 深圳市顺电连锁股份有限公司	深圳市华强北路上步工业区202栋2楼东	83286255
400020	重庆 重庆市渝中区中侨家用电器维修部	重庆市江北区建新南路18号城市领地A栋附2楼7号门市	63527117
530001	南宁 南宁市南方家用电器维修中心	广西南宁市唐山路29号首层	3118895/3907787
650051	昆明 昆明松和电器有限公司	昆明市环城北路280号	3645557
430015	武汉 武汉市江岸区兆利家电维修中心	汉口解放大道1439号4栋3单元101室	85790611
410007	长沙 长沙市俊铭电器有限公司	长沙市车站南路934-940号	4148005
610017	成都 成都市武侯区金维电子经营部	成都市大安东路57号3-6号	66656887
528200	佛山 佛山市禅城区得盛家用电器维修部	佛山市城门西商业街10号	83213535
350001	福州 福州福春电器维修服务有限公司	福州市塔头路328号顺意园一楼店面(福州锅炉厂对面)	87582122
325000	温州 温州市声像技术服务公司	温州市锦绣路利府花园5幢一层南1-05号	88850706/10187

上海涵思贸易有限公司可办理零件及产品邮购 电话:(021) 64606449 / 64584260

E-mail: sp-order@hansi.sh.cn

邮编: 201100

注: 如果当地无特约维修站, 请与就近的维修站联系。

固话免费咨询热线: 800-820-1357

手机用户咨询热线: 400-820-1357

BRAUN
德国博朗

博朗(上海)国际贸易有限公司

地址: 上海市外高桥保税区菲拉路55号综合楼第四层A部位

售后服务日常联系地址: 中国上海浦东三林路550号 邮编: 200124

上述售后服务部地址确定于2009年11月, 可能有不定期更新。如有疑问, 请咨询客户服务热线。

固话免费咨询热线: 800-820-1357

手机用户咨询热线: 400-820-1357

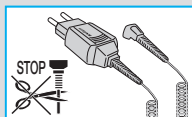

Our products are designed to meet the highest standards of quality, functionality and design. We hope you enjoy your new Braun Shaver.

Warning

Your shaving system is provided with a special cord set, which has an integrated Safety Extra Low Voltage power supply. Do not exchange or tamper with any part of it, otherwise there is risk of an electric shock.

This appliance is not intended for use by children or persons with reduced physical, sensory or mental capabilities, unless they are supervised by a person responsible for their safety. In general, we recommend that you keep the appliance out of reach of children. Children should be supervised to ensure that they do not play with the appliance.

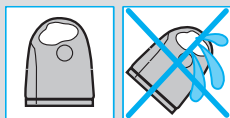

To prevent the cleaning fluid from leaking, ensure that the Clean&Renew station is placed on a flat surface. When a cleaning cartridge is installed, do not tip, move suddenly or transport the station in any way as cleaning fluid might spill out of the cartridge. Do not place the station inside a mirror cabinet, nor over a radiator, nor place it on a polished or lacquered surface.

The cleaning cartridge contains a highly flammable liquid so keep it away from sources of ignition. Do not smoke near the station. Do not expose to direct sunlight for long periods of time.

Do not refill the cartridge and use only original Braun refill cartridges.

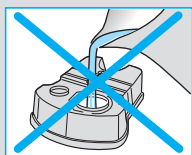

Description

Clean&Renew station

- ① Cleaning fluid display
- ② Lift button for cartridge exchange
- ③ Station-to-shaver contacts
- ④ Start button
- ④a Fast clean button
- ⑤ Cleaning program indicators
- ⑥ Station power socket
- ⑦ Cleaning cartridge

Shaver

- ⑧ Foil & Cutter cassette
- ⑨ Cassette «release» button
- ⑩ Shaver head «lock» switch
- ⑪ Pop-out long hair trimmer

- ⑫ On/off switch
- ⑬ (-) setting button (sensitive)
- ⑭ (+) setting button (intensive)
- ⑮ Reset button
- ⑯ Shaver display
- ⑰ Shaver-to-station contacts
- ⑱ Shaver power socket
- ⑲ Travel case
- ⑳ Special cord set

Before shaving

Prior to first use you must connect the shaver to an electrical outlet using the special cord set ⑳ or alternatively proceed as below.

Installing the Clean&Renew station

- Using the special cord set ⑳, connect the station power socket ⑥ to an electrical outlet.
- Press the lift button ② to open the housing.
- Hold the cleaning cartridge ⑦ down on a flat, stable surface (e.g. table).
- Carefully remove the lid from the cartridge.
- Slide the cartridge into the base of the station as far as it will go.
- Slowly close the housing by pushing it down until it locks.

The cleaning fluid display ① will show how much fluid is in the cartridge:

 up to 30 cleaning cycles available

 up to 7 cleaning cycles remaining

 new cartridge required

Charging and cleaning the shaver

Insert the shaver head down into the cleaning station. (The contacts ⑰ on the back of the shaver will align with the contacts ③ in the cleaning station).

If required, the Clean&Renew station will automatically charge the shaver. The hygiene status of the shaver will also be analyzed and one of the following cleaning program indicators ⑤ will light up:

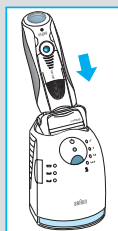
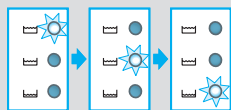
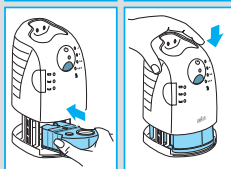
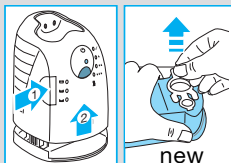
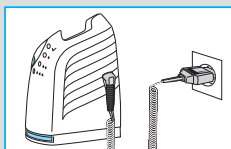

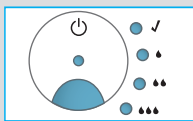

- « ✓ » shaver is clean
- « ● » short economical cleaning required
- « ●● » normal level of cleaning required
- « ●●● » high intensive cleaning required

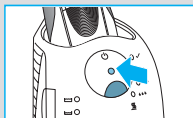

If the station selects one of the required cleaning programs, it will not start unless you press the start button (4). **For best shaving results, we recommend cleaning after each shave.**

Whilst cleaning is in progress, the respective cleaning program indicator will blink. Each cleaning program consists of several cycles, where cleaning fluid is flushed through the shaver head and a heat drying process dries the shaver. Depending on the program selected the total cleaning time will range from 32 to 43 minutes.

The cleaning programs should not be interrupted. Please note that whilst the shaver is drying, the shaving head may be hot and wet. When the program is finished, the blue « ✓ » indicator will light up. Your shaver is now clean and ready for use.

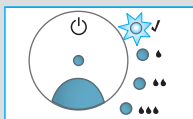

Fast cleaning

Push the fast clean button (4a) to activate the fast clean program without drying. This program takes about 25 seconds only and is recommended when you do not have time to wait for one of the automatic cleaning programs. If you remove the shaver just after the program has finished, wipe off the shaver head with a tissue to avoid dripping.

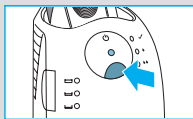

Stand-by mode

10 minutes after completing the charging or cleaning session, the Clean&Renew station switches to the stand-by mode: The indicators of the Clean&Renew station turn off.

Shaver display

The shaver display (16) shows the charge status of the battery on the left, and the hygiene status on the right. (6 dark segments are shown on each side when the battery is fully charged and the shaver is hygienically clean).



Battery segments:

During charging or when using the shaver, the respective battery segments will blink. When fully charged all 6 segments are shown. With decreasing charge the segments gradually disappear.



Low charge indicator:

The low charge indicator provided with a red frame blinks to indicate that the charge has dropped below 20%. The remaining battery capacity is sufficient for 2 to 3 shaves.

Hygiene segments:

All 6 hygiene segments will appear after the shaver has been cleaned in the Clean&Renew station. When the shaver is being used, the hygiene segments will gradually disappear. Once the shaver is returned to the station, the system will automatically select the appropriate cleaning program and restore the segments to maximum hygiene. Given that rinsing the shaver under tap water is not as hygienic as the cleaning station, the hygiene segments will only restore themselves when the shaver has been cleaned in the Clean&Renew station.

Charging information

- A full charge provides up to 50 minutes of cordless shaving time. This may vary according to your beard growth.
- The best environmental temperature for charging is between 5 °C to 35 °C. Do not expose the shaver to temperatures higher than 50 °C for extended periods of time.

Personalizing your shaver

Personalizing your shaver

With the (-) ¹³ and (+) ¹⁴ buttons you can choose the best setting for shaving different areas of your face and as per your specific needs. The different settings are indicated by the pilot light incorporated in the on/off switch ¹²:



- dark blue (powerful shave)
- light blue (normal)
- white (for a thorough comfortable shave in sensitive areas of your face such as neck)

For a thorough and fast shave we recommend the (+) setting.

When switching on next time, the last used setting will be activated.

How to use

Press the on/off switch ⑫ to operate the shaver:

- The pivoting shaver head and floating foils automatically adjust to every contour of your face.
- To shave hard to reach areas (e.g. under the nose) slide the shaver head «lock» switch ⑩ to the back position to lock the pivoting head at an angle.
- To trim sideburns, moustache or beard, slide the pop-out long hair trimmer upwards.

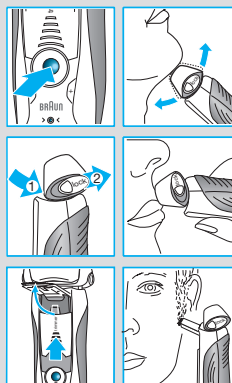

Tips for the perfect shave

For best shaving results, Braun recommends you follow 3 simple steps:

1. Always shave before washing your face.
2. At all times, hold the shaver at right angles (90°) to your skin.
3. Stretch your skin and shave against the direction of your beard growth.

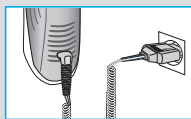
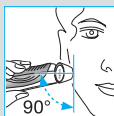

Shaving with the cord

If the shaver has run out of power (discharged), and you do not have the time to recharge it in the Clean&Renew station, you may also shave with the shaver connected to an electrical outlet via the special cord set.

Cleaning

Automatic cleaning

After each shave, return the shaver to the Clean&Renew station and proceed as described above in the section «Before shaving».

All charging and cleaning needs are then automatically taken care of. With daily use, a cleaning cartridge should be sufficient for about 30 cleaning cycles.

The hygienic cleaning cartridge contains alcohol, which once opened will naturally evaporate slowly into the surrounding air. Each cartridge, if not used daily, should be replaced after approximately 8 weeks.

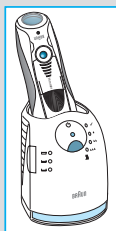

The cleaning cartridge also contains lubricants, which may leave residual marks on the outer foil frame after cleaning. However, these marks can be removed easily by wiping gently with a cloth or soft tissue paper.

Manual cleaning



The shaver head is suitable for cleaning under running tap water.

Warning: Detach the shaver from the power supply before cleaning the shaver head in water.

Rinsing the shaving head under running water is an alternative way to keep the shaver clean, especially when travelling:

- Switch the shaver on (cordless) and rinse the shaving head under hot running water. You may use liquid soap without abrasive substances. Rinse off all foam and let the shaver run for a few more seconds.
- Next, switch off the shaver, press the «release» button ⑨ to remove the Foil & Cutter cassette ⑧ and let it dry.
- If you regularly clean the shaver under water, then once a week apply a drop of light machine oil on top of the Foil & Cutter cassette.

Alternatively, you may clean the shaver using the brush provided:

- Switch off the shaver. Remove the Foil & Cutter cassette ⑧ and tap it out on a flat surface. Using the brush, clean the inner area of the pivoting head. However, do not clean the cassette with the brush as this may damage it.

Cleaning the housing

From time to time clean the housing of the shaver and the Clean&Renew station with a damp cloth, especially inside the cleaning chamber where the shaver rests.

Replacing the cleaning cartridge

After having pressed the lift button ② to open the housing, wait for a few seconds before removing the used cartridge to avoid any dripping. Before discarding the used cartridge, make sure to close the openings using the lid of the new cartridge, since the used cartridge will contain contaminated cleaning solution.

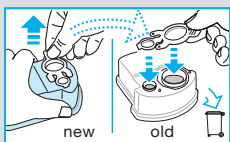
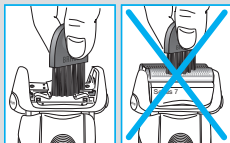
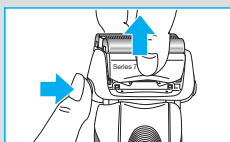
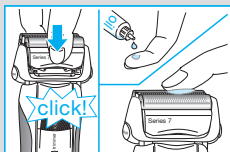
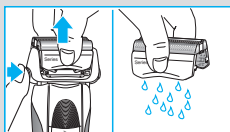
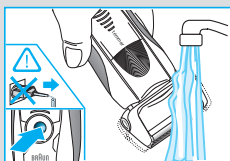

Keeping your shaver in top shape



Replacing the Foil & Cutter cassette / reset

To maintain 100% shaving performance, replace the Foil & Cutter cassette ^⑧, when the replacement symbol lights up on the shaver display ^⑯ (after about 18 months) or when cassette is worn.

The replacement symbol will remind you during the next 7 shaves to replace the Foil & Cutter cassette. Then the shaver will automatically reset the display.

After you have replaced the Foil & Cutter cassette, use a ball-pen to push the reset button ^⑰ for at least 3 seconds to reset the counter. While doing so, the replacement light blinks and goes off when the reset is complete. The manual reset can be done at any time.

Accessories

Available at your dealer or Braun Service Centres:

- **Foil & Cutter cassette 70S**
- **Cleaning cartridge Clean&Renew CCR**

Environmental notice

This product contains rechargeable batteries. In the interest of protecting the environment, please do not dispose of the product in household waste at the end of its useful life. Disposal can take place at a Braun Service Centre or at appropriate collection points provided in your country.



The cleaning cartridge can be disposed with regular household waste.

Subject to change without notice.

For electric specifications, see printing on the special cord set.